



SILERGY

SY6282L

6V, 2.5A Low Loss Power Distribution Switch

General Description

SY6282L is ultra-low $R_{DS(ON)}$ switch with programmable current limit to protect the power source from over current and short circuit conditions. It incorporates over temperature protection and reverse blocking function.

Ordering Information

SY6282 □(□□)□
 □ Temperature Code
 □ Package Code
 □ Optional Spec Code

Ordering Number	Package type	Note
SY6282LACC	TSOT23-5	

Features

- Input Voltage: 2.4V to 6V
- 2.5A Load Current Capability
- Programmable Current limit
- Over Temperature Protection
- Reverse Blocking (No Body Diode)
- OUT Can be Forced Higher Than IN at Shutdown
- Compact TSOT23-5 Package Minimizes the Board Space
- RoHS Compliant and Halogen Free

Applications

- USB 3G Datacard
- USB Dongle
- MiniPCI Accessories
- USB Charger
- Public Place Multi-USB Charger

Typical Application

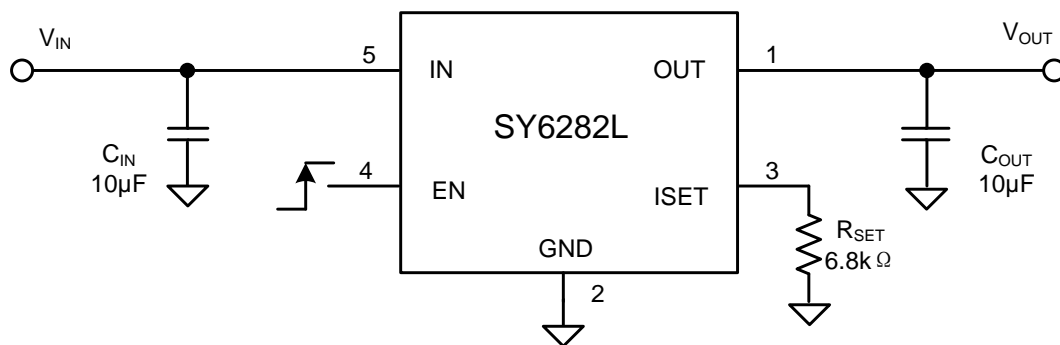
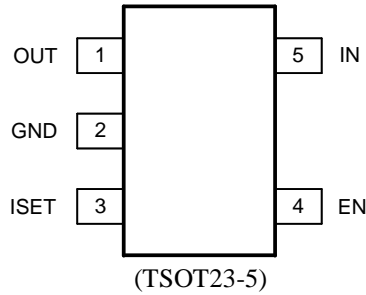

Figure1. Schematic Diagram

Pinout (top view)



Top mark: **Vmxyz** for SY6282LACC (Device code: Vm, x=*year code*, y=*week code*, z=*lot number code*)

Pin Name	Pin number	Pin Description
OUT	1	Output pin, decoupled with a 10μF capacitor to GND.
GND	2	Ground pin.
ISET	3	Current limit programming pin. Connect a resistor R _{SET} from this pin to ground to program the current limit: $I_{LIM} (A) = 6800/R_{SET} (\Omega)$
EN	4	ON/OFF control. Pull high to enable IC. Do not leave it floating.
IN	5	Input pin, decoupled with a 10μF capacitor to GND.

Block Diagram

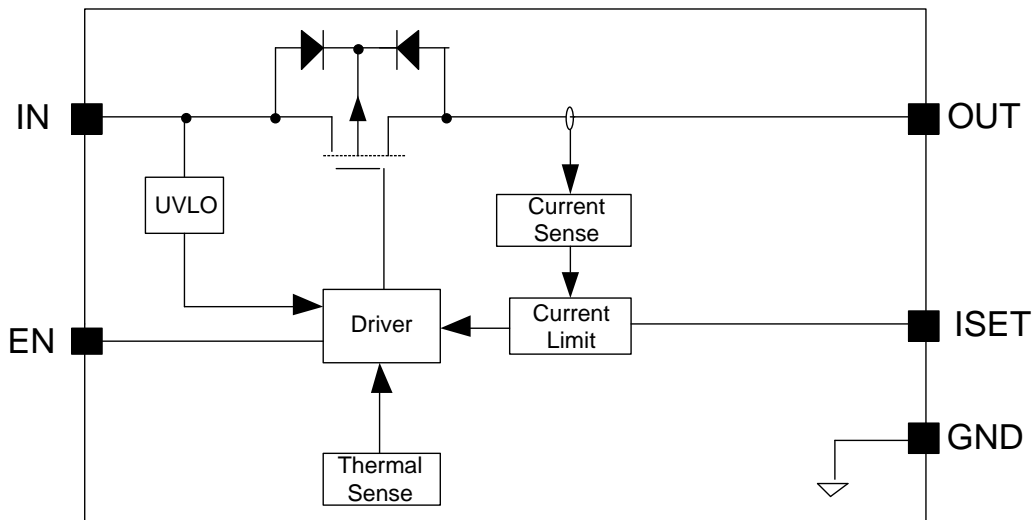

Figure2. Block Diagram



Absolute Maximum Ratings (Note 1)

IN, OUT, EN, ISET	-----	-0.3V to 7V
Power Dissipation, P _D @ T _A = 25°C TSOT23-5	-----	1.46W
Package Thermal Resistance (Note 2)		
θ _{JA}	-----	68.5°C/W
θ _{JC}	-----	10.9°C/W
Junction Temperature Range	-----	-40°C to 150°C
Lead Temperature (Soldering, 10 sec.)	-----	260°C
Storage Temperature Range	-----	-65°C to 150°C

Recommended Operating Conditions (Note 3)

IN	-----	2.4V to 6V
OUT, ISET	-----	0V to 6V
EN	-----	0V to IN
Junction Temperature Range	-----	-40°C to 125°C
Ambient Temperature Range	-----	-40°C to 85°C

Electrical Characteristics

(V_{IN} = 5V, C_{OUT} = 10μF, T_A = 25°C, unless otherwise specified.)

Parameter	Symbol	Test Conditions	Min	Typ	Max	Unit
Input Voltage Range	V _{IN}		2.4		6	V
Shutdown Input Current	I _{SHDN}	Open load, IC disabled		0.2	1	μA
Quiescent Supply Current	I _Q	Open load, IC enabled		38		μA
FET R _{ON}	R _{DS(ON)}			80		mΩ
EN Rising Threshold	V _{EN(H)}		2			V
EN Falling Threshold	V _{EN(L)}				0.8	V
EN Leakage Current	I _{EN}	V _{EN} = 5.0V			1	μA
IN UVLO Threshold	V _{IN_UVLO}				2.3	V
IN UVLO Hysteresis	V _{IN_HYS}			0.1		V
Over Current Limit	I _{LIM}	R _{SET} = 6.8kΩ	0.75	1	1.25	A
Programmable current limit range	I _{RANGE}		0.4		2.5	A
Turn-on Time	t _{ON}	R _L = 10Ω, C _{OUT} = 1μF		130		μs
Turn-off Time	t _{OFF}	R _L = 10Ω, C _{OUT} = 1μF		20		μs
Thermal Shutdown Temperature	t _{SD}			150		°C
Thermal Shutdown Hysteresis	t _{SD_HYS}			20		°C

Note 1: Stresses beyond the “Absolute Maximum Ratings” may cause permanent damage to the device. These are stress ratings only. Functional operation of the device at these or any other conditions beyond those indicated in the operational sections of the specification is not implied. Exposure to absolute maximum rating conditions for extended periods may affect device reliability.

Note 2: θ_{JA} is measured in the natural convection at T_A = 25°C on a Silergy test board. Pin 2 of TSOT23-5 package is the case position for θ_{JC} measurement.

Note 3: The device is not guaranteed to function outside its operating conditions.

Typical Performance Characteristics

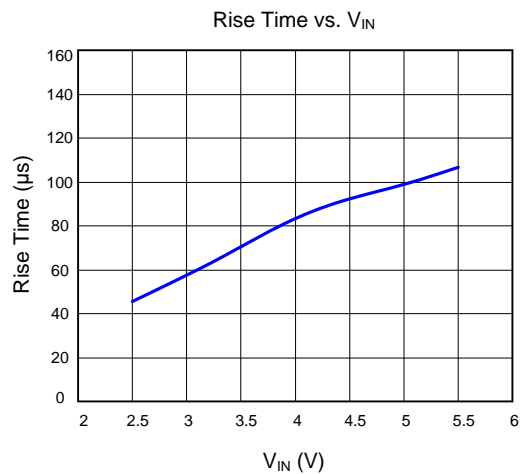
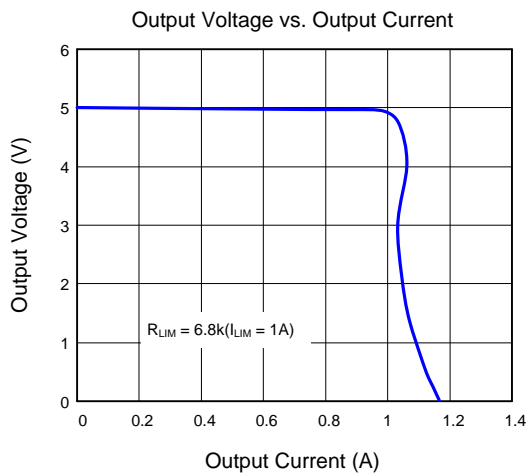
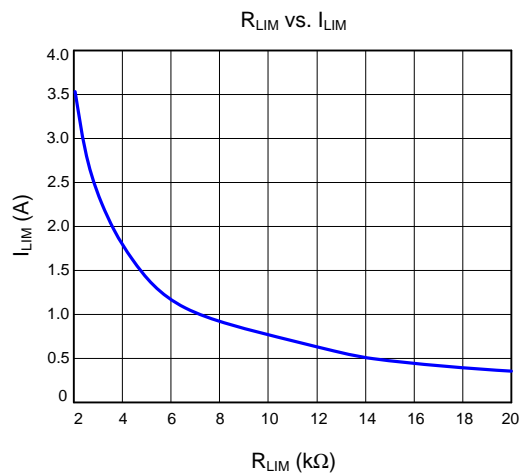
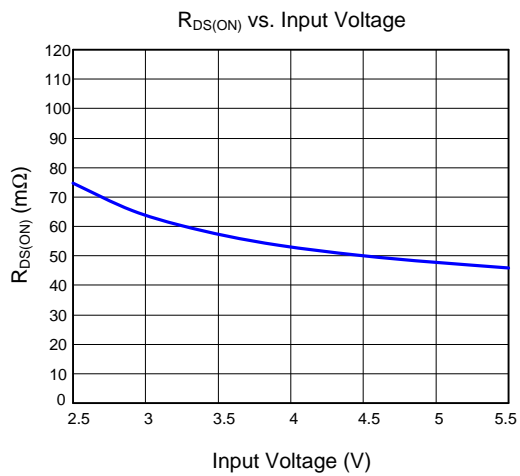
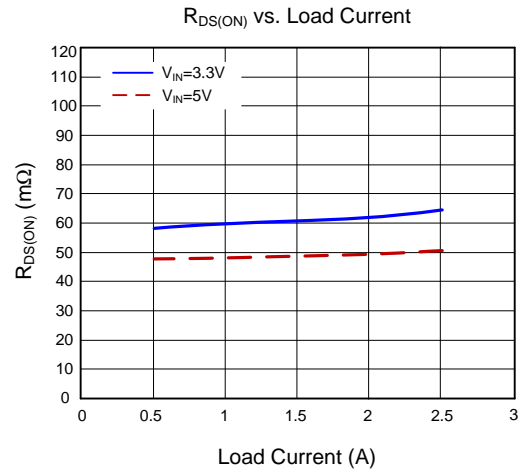
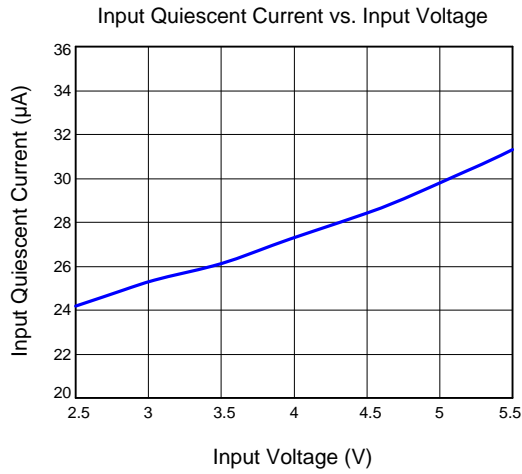

Startup from Enable
($V_{IN}=3.3V$, $I_O=2.5A$)

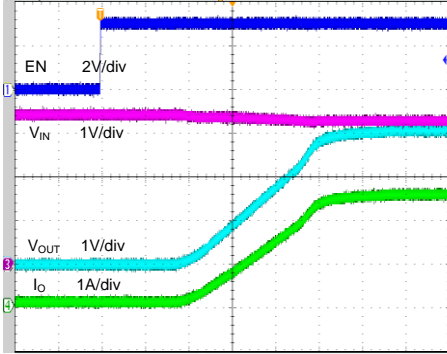

Time (40 μ s/div)

Shutdown from Enable
($V_{IN}=3.3V$, $I_O=2.5A$)

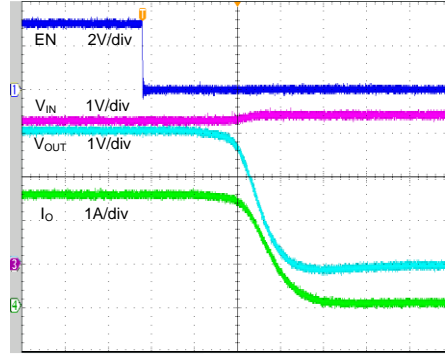

Time (2 μ s/div)

Startup from V_{IN}
($V_{IN}=3.3V$, $I_O=0.5A$)

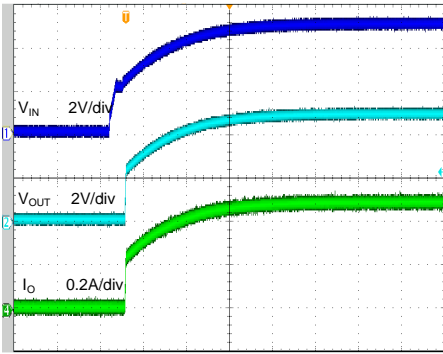

Time(2ms/div)

Shutdown from V_{IN}
($V_{IN}=3.3V$, $I_O=0.5A$)

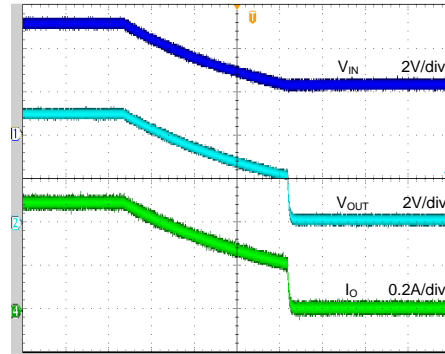

Time (2ms/div)

Applications Information

SY6282L is a current limited P-channel MOSFET power switch with over current and over temperature protections. There is no body diode across the drain and the source of the MOSFET. It prevents the current flow from the output to the input after the chip is disabled.

Over Current Protection

When the over current condition is detected, the switch is regulated to achieve constant output current. If the over current condition lasts for a long time, and results in a junction temperature over 150°C, the switch will be shutdown. Once the junction temperature drops to 130°C, the part will restart.

Supply Filter Capacitor

In order to prevent the input voltage from dropping during hot-plug condition, a 10µF ceramic capacitor from VIN to GND is strongly recommended. However, higher capacitance could help reduce the voltage drop. Furthermore, an output short will cause ringing on the input without the input capacitor. It could destroy the internal circuitry when the input transient voltage exceeds the absolute maximum supply voltage even for a short duration.

Current Limiting Setting

Current limit is programmable to protect the power source from over current and short circuit conditions. Connect a resistor R_{SET} from ISET pin to GND to program the current limit:

$$I_{LIM} (A) = 6800 / R_{SET} (\Omega)$$

The minimum current limit is 0.4A. Current limit beyond 2.5A is not recommended.

Maximum Input Voltage Consideration:

For any application, input voltage for SY6282L should not be allowed to exceed the maximum recommended value (6V).

Below is a typical application circuit for SY6282L. The front stage is a non-synchronous Boost stage and the input power supply can be a battery or an adapter.

Some adapters may have poor output voltage tolerance, or may have large output voltage overshoot if the adapter is hot plug in directly. The voltage overshoot higher than V_{IN} (6V) will significantly reduce the reliability of SY6282L and may even lead to IC EOS failure.

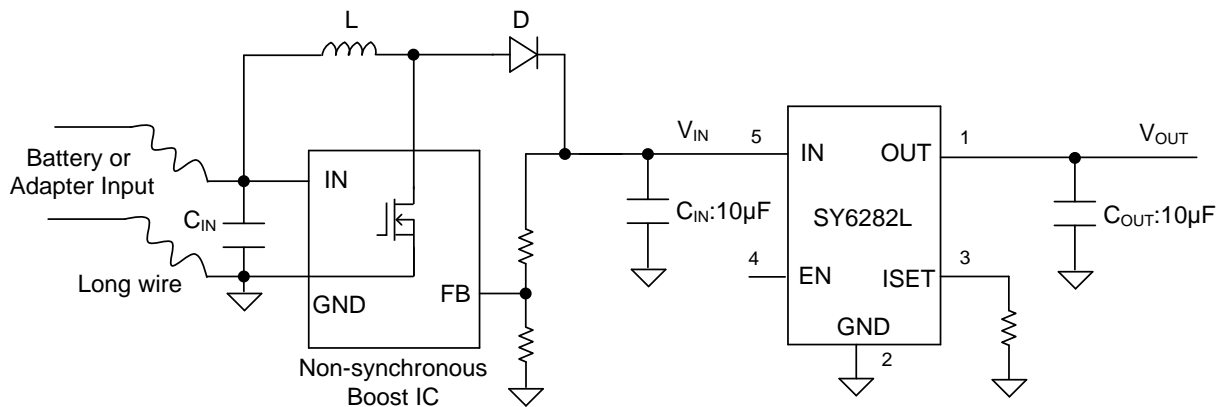

Figure3. USB Host Application

PCB Layout Guide

To achieve a better performance, the following guidelines must be strictly followed:

- 1) Keep all power traces as short and wide as possible and use at least 2 ounce copper for all power traces.
- 2) Place a ground plane under all circuitry to lower both resistance and inductance and improve DC and transient performance.
- 3) Locate the output capacitors as close to the connectors as possible to lower the impedance (mainly inductance) between the port and the capacitor and improve transient performance.
- 4) Input and output capacitors should be placed close to the IC and connected to the ground plane to reduce noise coupling.
- 5) Locate the ceramic bypass capacitors as close as possible to the IN pin and OUT pin of SY6282L.

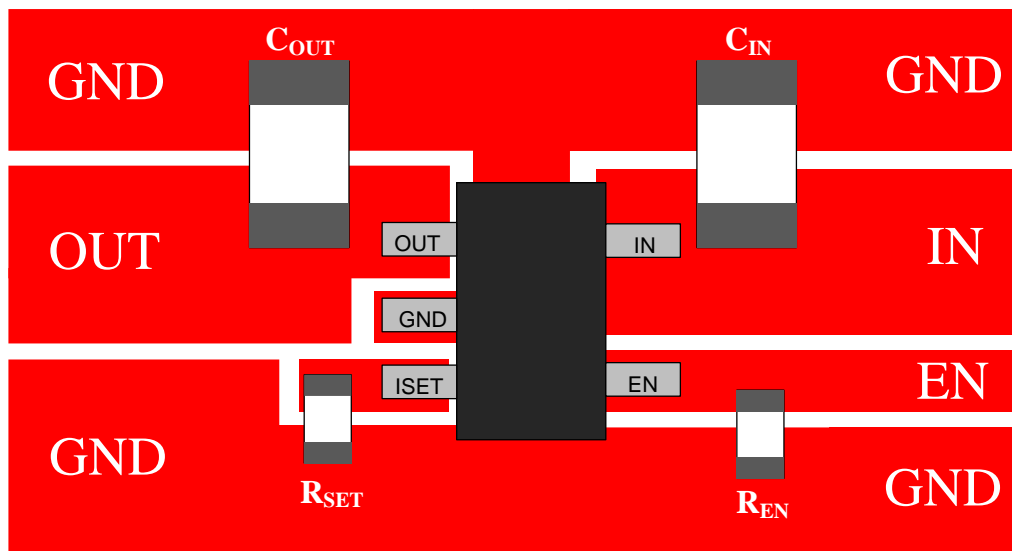
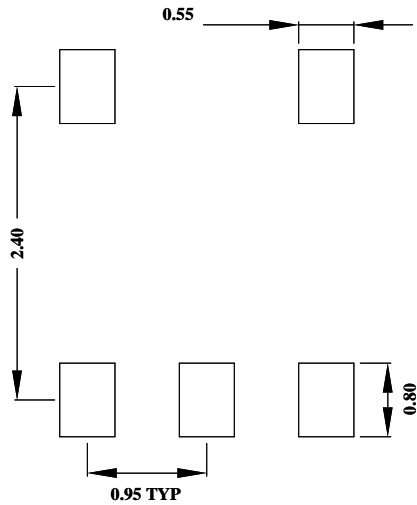
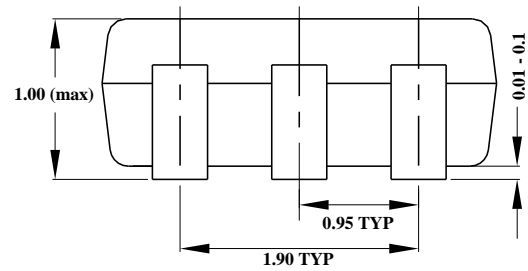
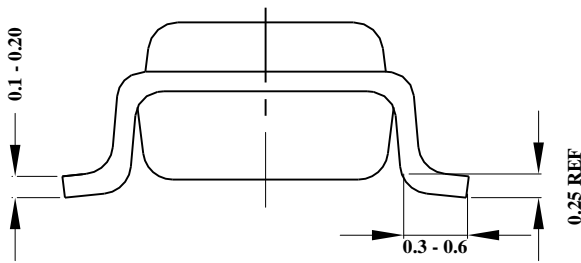
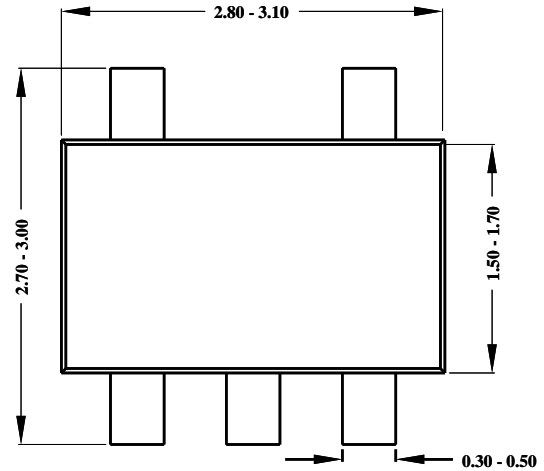

Figure4. PCB Layout Suggestion

TSOT23-5 Package outline & PCB Layout Design



Recommended Pad Layout



**Notes: All dimensions are in millimeters.
All dimensions don't include mold flash & metal burr.**

Taping & Reel Specification

1. Taping orientation

TSOT23-5

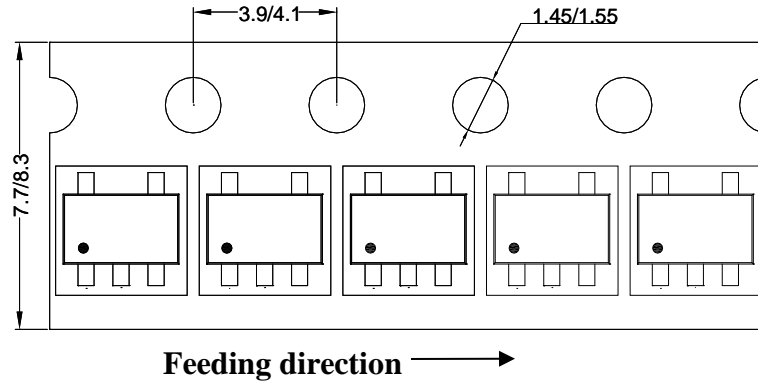

2. Carrier Tape & Reel specification for packages

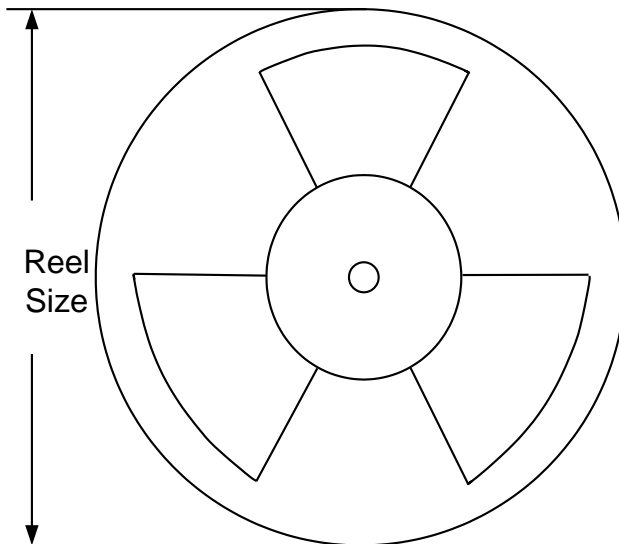

Package type	Tape width (mm)	Pocket pitch(mm)	Reel size (Inch)	Trailer length(mm)	Leader length (mm)	Qty per reel
TSOT23-5	8	4	7"	280	160	3000

3. Others: NA



IMPORTANT NOTICE

- 1. Right to make changes.** Silergy and its subsidiaries (hereafter Silergy) reserve the right to change any information published in this document, including but not limited to circuitry, specification and/or product design, manufacturing or descriptions, at any time and without notice. This document supersedes and replaces all information supplied prior to the publication hereof. Buyers should obtain the latest relevant information before placing orders and should verify that such information is current and complete. All semiconductor products are sold subject to Silergy's standard terms and conditions of sale.
- 2. Applications.** Application examples that are described herein for any of these products are for illustrative purposes only. Silergy makes no representation or warranty that such applications will be suitable for the specified use without further testing or modification. Buyers are responsible for the design and operation of their applications and products using Silergy products. Silergy or its subsidiaries assume no liability for any application assistance or designs of customer products. It is customer's sole responsibility to determine whether the Silergy product is suitable and fit for the customer's applications and products planned. To minimize the risks associated with customer's products and applications, customer should provide adequate design and operating safeguards. Customer represents and agrees that it has all the necessary expertise to create and implement safeguards which anticipate dangerous consequences of failures, monitor failures and their consequences, lessen the likelihood of failures that might cause harm and take appropriate remedial actions. Silergy assumes no liability related to any default, damage, costs or problem in the customer's applications or products, or the application or use by customer's third-party buyers. Customer will fully indemnify Silergy, its subsidiaries, and their representatives against any damages arising out of the use of any Silergy components in safety-critical applications. It is also buyers' sole responsibility to warrant and guarantee that any intellectual property rights of a third party are not infringed upon when integrating Silergy products into any application. Silergy assumes no responsibility for any said applications or for any use of any circuitry other than circuitry entirely embodied in a Silergy product.
- 3. Limited warranty and liability.** Information furnished by Silergy in this document is believed to be accurate and reliable. However, Silergy makes no representation or warranty, expressed or implied, as to the accuracy or completeness of such information and shall have no liability for the consequences of use of such information. In no event shall Silergy be liable for any indirect, incidental, punitive, special or consequential damages, including but not limited to lost profits, lost savings, business interruption, costs related to the removal or replacement of any products or rework charges, whether or not such damages are based on tort or negligence, warranty, breach of contract or any other legal theory. Notwithstanding any damages that customer might incur for any reason whatsoever, Silergy' aggregate and cumulative liability towards customer for the products described herein shall be limited in accordance with the Standard Terms and Conditions of Sale of Silergy.
- 4. Suitability for use.** Customer acknowledges and agrees that it is solely responsible for compliance with all legal, regulatory and safety-related requirements concerning its products, and any use of Silergy components in its applications, notwithstanding any applications-related information or support that may be provided by Silergy. Silergy products are not designed, authorized or warranted to be suitable for use in life support, life-critical or safety-critical systems or equipment, nor in applications where failure or malfunction of an Silergy product can reasonably be expected to result in personal injury, death or severe property or environmental damage. Silergy assumes no liability for inclusion and/or use of Silergy products in such equipment or applications and therefore such inclusion and/or use is at the customer's own risk.
- 5. Terms and conditions of commercial sale.** Silergy products are sold subject to the standard terms and conditions of commercial sale, as published at <http://www.silergy.com/stdterms>, unless otherwise agreed in a valid written individual agreement specifically agreed to in writing by an authorized officer of Silergy. In case an individual agreement is concluded only the terms and conditions of the respective agreement shall apply. Silergy hereby expressly objects to and denies the application of any customer's general terms and conditions with regard to the purchase of Silergy products by the customer.
- 6. No offer to sell or license.** Nothing in this document may be interpreted or construed as an offer to sell products that is open for acceptance or the grant, conveyance or implication of any license under any copyrights, patents or other industrial or intellectual property rights. Silergy makes no representation or warranty that any license, either express or implied, is granted under any patent right, copyright, mask work right, or other intellectual property right. Information published by Silergy regarding third-party products or services does not constitute a license to use such products or services or a warranty or endorsement thereof. Use of such information may require a license from a third party under the patents or other intellectual property of the third party, or a license from Silergy under the patents or other intellectual property of Silergy.

For more information, please visit: www.silergy.com

© 2018 Silergy Corp.
Reserved.

All Rights