

# Test Report

No.: NGBEC24007459004\_1

Date: Dec 30, 2024

Page 1 of 21

Client Name: Silergy Corp.

Client Address: Oleander Way, 802 West Bay Road, P.O. Box 32052, Grand Cayman KY1-1208, Cayman Islands

Sample Name: Surface Mounted Electric Component

Model No.: SOP8E

Client Ref. Information: AQFN/BGA/COF/COMBO/CPC/CSP/DFN/DIP/D-SMD/HDIP/GEM/LQFP/LGA/MDFN/MLGA/MQFN/MSOP/ODFN/QFN/PDFN/P-DIP/PLCC/SMB/SMC/SMD/SOD/SOP/SOT/SSOP/TO92/TO220/TO220F/TO252/TO263/TQFP/TSOP/TSSOP/TSOT/2ΦRadial-2L/3ΦRadial-2L/5ΦRadial-2L  
See attachment

The above sample(s) and information were provided by the client.

**THIS REPORT IS TO SUPERSEDE TEST REPORT NO.NGBEC24007459004, DATE: Dec 24, 2024.**

SGS Job No.: NBP24-007602

Sample Receiving Date: Dec 17, 2024

Testing Period: Dec 17, 2024 ~ Dec 24, 2024

Test Requested: Select test(s) as requested by the client.

Test Method(s): Please refer to next page(s).

Test Result(s): Please refer to next page(s).

Test Requirement	Conclusion
EU RoHS Directive (EU) 2015/863 amending Annex II to Directive 2011/65/EU - Lead, Mercury, Cadmium, Hexavalent chromium, Polybrominated biphenyls (PBB), Polybrominated diphenyl ethers (PBDE), Bis(2-ethylhexyl) phthalate (DEHP), Butyl benzyl phthalate (BBP), Dibutyl phthalate (DBP) and Diisobutyl phthalate (DIBP)	Pass
Element(s)	See Results
Halogen	See Results
Polyvinyl chloride (PVC)	See Results
Red Phosphorus	See Results

Signed for and on behalf of  
SGS-CSTC Standards Technical Services Co., Ltd. Ningbo Branch

*May Zhang*

May Zhang  
Approved Signatory

scan to see the report



066D9C3E



SGS-CSTC Standards Technical Services Co., Ltd.  
Ningbo Branch Chemical Laboratory

Unless otherwise agreed in writing, this document is issued by the Company subject to its General Conditions of Service printed overleaf, available on request or accessible at <http://www.sgs.com/en/Terms-and-Conditions.aspx> and, for electronic format documents, subject to Terms and Conditions for Electronic Documents at <http://www.sgs.com/en/Terms-and-Conditions/Terms-e-Documents.aspx>. Attention is drawn to the limitation of liability, indemnification and jurisdiction issues defined therein. Any holder of this document is advised that information contained hereon reflects the Company's findings at the time of its intervention only and within the limits of Client's instructions, if any. The Company's sole responsibility is to its Client and this document does not exonerate parties to a transaction from exercising all their rights and obligations under the transaction documents. This document cannot be reproduced except in full, without prior written approval of the Company. Any unauthorized alteration, forgery or falsification of the content or appearance of this document is unlawful and offenders may be prosecuted to the fullest extent of the law. Unless otherwise stated the results shown in this test report refer only to the sample(s) tested.

Attention: To check the authenticity of testing /inspection report & certificate, please contact us at telephone: (86-755) 8307 1443, or email: [CN.Doccheck@sgs.com](mailto:CN.Doccheck@sgs.com)

No.1177, Lingyun Road, Hi-Tech Zone, Ningbo, Zhejiang, China 315040 t E&E (86-574)89070249

[www.sgsgroup.com.cn](http://www.sgsgroup.com.cn)

中国·浙江·宁波高新区凌云路1177号 邮编: 315040 t HL (86-574)89070271 t ML (86-574)89070242 [sgs.china@sgs.com](mailto:sgs.china@sgs.com)

# Test Report

No.: NGBEC24007459004\_1

Date: Dec 30, 2024

Page 2 of 21

Test Requirement	Conclusion
Hexabromocyclododecane (HBCDD)	See Results
Perfluorooctanoic acid (PFOA) and its salts, Perfluorooctane sulfonic acid (PFOS) and its derivatives	See Results
AfPS GS 2019:01 PAK-Polycyclic Aromatic Hydrocarbons (PAHs)	See Results

## Test Result(s):

### Test Part Description:

SN ID	Sample No.	SGS Sample ID	Description
SN1	A1	NGB24-0074590-0001.C001	Black body with silvery pin

### Remarks:

- (1) 1 mg/kg = 1 ppm = 0.0001%
- (2) MDL = Method Detection Limit
- (3) ND = Not Detected (< MDL)
- (4) "-" = Not Regulated

**EU RoHS Directive (EU) 2015/863 amending Annex II to Directive 2011/65/EU - Lead, Mercury, Cadmium, Hexavalent chromium, Polybrominated biphenyls (PBB), Polybrominated diphenyl ethers (PBDE), Bis(2-ethylhexyl) phthalate (DEHP), Butyl benzyl phthalate (BBP), Dibutyl phthalate (DBP) and Diisobutyl phthalate (DIBP)**

**Test Method:** With reference to IEC 62321-4:2013+AMD1:2017, IEC 62321-5:2013, IEC 62321-7-2:2017 and IEC 62321-12:2023, analysis was performed by ICP-OES/AAS, UV-Vis and GC-MS.

Test Item(s)	Limit	Unit(s)	MDL	A1
Lead (Pb)	1000	mg/kg	2	ND
Mercury (Hg)	1000	mg/kg	2	ND
Cadmium (Cd)	100	mg/kg	2	ND
Hexavalent Chromium (Cr(VI))	1000	mg/kg	8	ND
Polybrominated biphenyls (PBB)	1000	mg/kg	-	ND
Monobrominated biphenyl (MonoBB)	-	mg/kg	25	ND
Dibrominated biphenyl (DiBB)	-	mg/kg	25	ND
Tribrominated biphenyl (TriBB)	-	mg/kg	25	ND
Tetrabrominated biphenyl (TetraBB)	-	mg/kg	25	ND
Pentabrominated biphenyl (PentaBB)	-	mg/kg	25	ND
Hexabrominated biphenyl (HexaBB)	-	mg/kg	25	ND
Heptabrominated biphenyl (HeptaBB)	-	mg/kg	25	ND
Octabrominated biphenyl (OctaBB)	-	mg/kg	25	ND
Nonabrominated biphenyl (NonaBB)	-	mg/kg	25	ND
Decabrominated biphenyl (DecaBB)	-	mg/kg	25	ND
Polybrominated diphenyl ethers (PBDE)	1000	mg/kg	-	ND
Monobrominated diphenyl ether (MonoBDE)	-	mg/kg	25	ND
Dibrominated diphenyl ether (DiBDE)	-	mg/kg	25	ND
Tribrominated diphenyl ether (TriBDE)	-	mg/kg	25	ND
Tetrabrominated diphenyl ether (TetraBDE)	-	mg/kg	25	ND



Unless otherwise agreed in writing, this document is issued by the Company subject to its General Conditions of Service printed overleaf, available on request or accessible at <http://www.sgs.com/en/Terms-and-Conditions.aspx> and, for electronic format documents, subject to Terms and Conditions for Electronic Documents at <http://www.sgs.com/en/Terms-and-Conditions/Terms-e-Document.aspx>. Attention is drawn to the limitation of liability, indemnification and jurisdiction issues defined therein. Any holder of this document is advised that information contained hereon reflects the Company's findings at the time of its intervention only and within the limits of Client's instructions, if any. The Company's sole responsibility is to its Client and this document does not exonerate parties to a transaction from exercising all their rights and obligations under the transaction documents. This document cannot be reproduced except in full, without prior written approval of the Company. Any unauthorized alteration, forgery or falsification of the content or appearance of this document is unlawful and offenders may be prosecuted to the fullest extent of the law. Unless otherwise stated the results shown in this test report refer only to the sample(s) tested.

**Attention: To check the authenticity of testing /inspection report & certificate, please contact us at telephone: (86-755) 8307 1443, or email: CN.Doccheck@sgs.com**

# Test Report

No.: NGBEC24007459004\_1

Date: Dec 30, 2024

Page 3 of 21

Test Item(s)	Limit	Unit(s)	MDL	A1
Pentabrominated diphenyl ether (PentaBDE)	-	mg/kg	25	ND
Hexabrominated diphenyl ether (HexaBDE)	-	mg/kg	25	ND
Heptabrominated diphenyl ether (HeptaBDE)	-	mg/kg	25	ND
Octabrominated diphenyl ether (OctaBDE)	-	mg/kg	25	ND
Nonabrominated diphenyl ether (NonaBDE)	-	mg/kg	25	ND
Decabrominated diphenyl ether (DecaBDE)	-	mg/kg	25	ND
Di-2-Ethyl Hexyl Phthalate (DEHP)	1000	mg/kg	50	ND
Benzyl Butyl Phthalate (BBP)	1000	mg/kg	50	ND
Dibutyl Phthalate (DBP)	1000	mg/kg	50	ND
Diisobutyl Phthalate (DIBP)	1000	mg/kg	50	ND

**Notes:**

- (1) The maximum permissible limit is quoted from RoHS Directive (EU) 2015/863.
- (2) IEC 62321 series is equivalent to EN 62321 series.
- (3) The restriction of DEHP, BBP, DBP and DIBP shall apply to medical devices, including in vitro medical devices, and monitoring and control instruments, including industrial monitoring and control instruments, from 22 July 2021.

**Element(s)**

**Test Method:** With reference to US EPA 3052:1996, analysis was performed by ICP-OES/AAS.

Test Item(s)	Unit(s)	MDL	A1
Arsenic(As)	mg/kg	10	ND
Beryllium(Be)	mg/kg	5	ND
Antimony(Sb)	mg/kg	10	ND

**Halogen**

**Test Method:** With reference to EN 14582:2016, analysis was performed by IC.

Test Item(s)	Unit(s)	MDL	A1
Fluorine(F)	mg/kg	20	ND
Chlorine(Cl)	mg/kg	50	ND
Bromine(Br)	mg/kg	50	ND
Iodine(I)	mg/kg	50	ND

**Polyvinyl chloride (PVC)**

**Test Method:** With reference to SGS in house method, analysis was performed by FTIR/HATR.

Test Item(s)	A1
Polyvinyl chloride (PVC)	Negative



Unless otherwise agreed in writing, this document is issued by the Company subject to its General Conditions of Service printed overleaf, available on request or accessible at <http://www.sgs.com/en/Terms-and-Conditions.aspx> and, for electronic format documents, subject to Terms and Conditions for Electronic Documents at <http://www.sgs.com/en/Terms-and-Conditions/Terms-e-Document.aspx>. Attention is drawn to the limitation of liability, indemnification and jurisdiction issues defined therein. Any holder of this document is advised that information contained hereon reflects the Company's findings at the time of its intervention only and within the limits of Client's instructions, if any. The Company's sole responsibility is to its Client and this document does not exonerate parties to a transaction from exercising all their rights and obligations under the transaction documents. This document cannot be reproduced except in full, without prior written approval of the Company. Any unauthorized alteration, forgery or falsification of the content or appearance of this document is unlawful and offenders may be prosecuted to the fullest extent of the law. Unless otherwise stated the results shown in this test report refer only to the sample(s) tested.  
**Attention: To check the authenticity of testing /inspection report & certificate, please contact us at telephone: (86-755) 8307 1443, or email: CN.Doccheck@sgs.com**

SGS-CS17 Standards Technical Services Co., Ltd.  
Ningbo Branch Chemical Laboratory

No.1177, Lingyun Road, Hi-Tech Zone, Ningbo, Zhejiang, China 315040 tE&E (86-574)89070249  
 中国·浙江·宁波高新区凌云路1177号 邮编: 315040 tHL (86-574)89070271 tML (86-574)89070242 sgs.china@sgs.com

www.sgs.com.cn

# Test Report

No.: NGBEC24007459004\_1

Date: Dec 30, 2024

Page 4 of 21

**Notes:**

- (1) Negative=Undetectable, Positive=Detectable
- (2) The test was subcontracted to SGS Shanghai chemical lab.

**Red Phosphorus**

**Test Method:** With reference to SGS In house method, analysis was performed by ICP-OES and Pyrolysis-GC-MS.

Test Item(s)	CAS No.	Unit(s)	MDL	A1
Red Phosphorus	7723-14-0	mg/kg	500	ND

**Notes:**

- (1) The testing result is based on the worst-case scenario, and confirmed by Pyrolysis-GC-MS.
- (2) The test was subcontracted to SGS Shanghai chemical lab.

**Hexabromocyclododecane (HBCDD)**

**Test Method:** With reference to US EPA 3550C:2007, analysis was performed by GC-MS.

Test Item(s)	CAS No.	Unit(s)	MDL	A1
Hexabromocyclododecane (HBCDD)	134237-50-6 /134237-51-7 /134237-52-8 /25637-99-4 /3194-55-6	mg/kg	10	ND

**Perfluorooctanoic acid (PFOA) and its salts, Perfluorooctane sulfonic acid (PFOS) and its derivatives**

**Test Method:** Modified EN 17681-1:2022, analysis was performed by LC-MS or LC-MS/MS.

Test Item(s)	CAS No.	Unit(s)	MDL	A1
<b>PFOS, its salts and related compounds</b>				
Perfluorooctane sulfonic acid (PFOS), its salts^	1763-23-1	mg/kg	0.010	ND
N-ethylperfluoro-1-octanesulfonamide (N-EtFOSA)	4151-50-2	mg/kg	0.010	ND
N-methylperfluoro-1-octanesulfonamide (N-MeFOSA)	31506-32-8	mg/kg	0.010	ND
2-(N-ethylperfluoro-1-octanesulfonamido)-ethanol (N-EtFOSE)	1691-99-2	mg/kg	0.010	ND
2-(N-methylperfluoro-1-octanesulfonamido)-ethanol (N-MeFOSE)	24448-09-7	mg/kg	0.010	ND
Perfluorooctane Sulfonamide (PFOSA), its salts^	754-91-6	mg/kg	0.010	ND



Unless otherwise agreed in writing, this document is issued by the Company subject to its General Conditions of Service printed overleaf, available on request or accessible at <http://www.sgs.com/en/Terms-and-Conditions.aspx> and, for electronic format documents, subject to Terms and Conditions for Electronic Documents at <http://www.sgs.com/en/Terms-and-Conditions/Terms-e-Document.aspx>. Attention is drawn to the limitation of liability, indemnification and jurisdiction issues defined therein. Any holder of this document is advised that information contained hereon reflects the Company's findings at the time of its intervention only and within the limits of Client's instructions, if any. The Company's sole responsibility is to its Client and this document does not exonerate parties to a transaction from exercising all their rights and obligations under the transaction documents. This document cannot be reproduced except in full, without prior written approval of the Company. Any unauthorized alteration, forgery or falsification of the content or appearance of this document is unlawful and offenders may be prosecuted to the fullest extent of the law. Unless otherwise stated the results shown in this test report refer only to the sample(s) tested.

**Attention: To check the authenticity of testing /inspection report & certificate, please contact us at telephone: (86-755) 8307 1443, or email: CN.Doccheck@sgs.com**

# Test Report

No.: NGBEC24007459004\_1

Date: Dec 30, 2024

Page 5 of 21

Test Item(s)	CAS No.	Unit(s)	MDL	A1
Perfluorooctane sulfonamidoacetic Acid (FOSAA), its salts^	2806-24-8	mg/kg	0.010	ND
N-Methylperfluoro-1-octanesulfonamidoacetic Acid (N-MeFOSAA), its salts^	2355-31-9	mg/kg	0.010	ND
N-Ethylperfluorooctane sulfonamidoacetic Acid (N-EtFOSAA), its salts^	2991-50-6	mg/kg	0.010	ND
Sum of Perfluorooctane sulfonic acid (PFOS) and its derivatives	-	mg/kg	-	ND
<b>PFOA, its salts</b>				
Perfluorooctanoic acid (PFOA), its salts^	335-67-1	mg/kg	0.010	ND

**Notes:**

1. ^=Substances refer to its salts/derivative listed in below table.

Substance Name	CAS No.
<b>PFOS, its salts &amp; derivatives</b>	
Perfluorooctane sulfonic acid (PFOS)	1763-23-1
Potassium Perfluorooctanesulfonate (PFOS-K)	2795-39-3
Perfluorooctanesulfonic acid, lithium salt (PFOS-Li)	29457-72-5
Sodium perfluorooctanesulfonate (PFOS-Na)	4021-47-0
Ammonium perfluorooctanesulfonate (PFOS-NH <sub>4</sub> )	29081-56-9
Perfluorooctane sulfonate diethanolamine salt (PFOS-NH <sub>2</sub> (C <sub>2</sub> H <sub>4</sub> OH) <sub>2</sub> )	70225-14-8
Perfluorooctanesulfonic acid, tetraethylammonium salt (PFOS-N(C <sub>2</sub> H <sub>5</sub> ) <sub>4</sub> )	56773-42-3
N-decyl-N,N-dimethyldecan-1-aminium 1,1,2,2,3,3,4,4,5,5,6,6,7,7,8,8,8-heptadecafluorooctane-1-sulfonate (PFOS-N(C <sub>10</sub> H <sub>21</sub> ) <sub>2</sub> (CH <sub>3</sub> ) <sub>2</sub> )	251099-16-8
TetrabutylAmmonium perfluorooctanesulfonate (PFOS-N(C <sub>4</sub> H <sub>9</sub> ) <sub>4</sub> )	111873-33-7
Perfluorooctane Sulfonyl fluoride (PFOS-F)	307-35-7
Magnesium bis(heptadecafluorooctanesulphonate) (PFOS-Mg)	91036-71-4
Piperidine 1,1,2,2,3,3,4,4,5,5,6,6,7,7,8,8,8-heptadecafluorooctanesulfonate	71463-74-6
Perfluorooctanesulfonate	45298-90-6
Triethylammonium perfluorooctane sulfonate (PFOS-N(C <sub>2</sub> H <sub>5</sub> ) <sub>3</sub> )	54439-46-2
Tetramethylammonium perfluorooctane sulfonate (PFOS-N(CH <sub>3</sub> ) <sub>4</sub> )	56773-44-5
N,N,N-Tripropylpentan-1-aminium heptadecafluorooctane-1-sulfonate (PFOS-N(C <sub>3</sub> H <sub>7</sub> ) <sub>3</sub> (C <sub>5</sub> H <sub>11</sub> ))	56773-56-9
N,N-Dibutyl-N-methylbutan-1-aminium heptadecafluorooctane-1-sulfonate (PFOS-N(C <sub>4</sub> H <sub>9</sub> ) <sub>3</sub> (CH <sub>3</sub> ))	124472-68-0
Iodonium, bis[4-(1,1-dimethylethyl)phenyl]-, salt with perfluoro-1-octanesulfonic acid (1:1)	213740-80-8
Diphenyl(2,4,6-trimethylphenyl)sulfonium perfluoro-1-octanesulfonate	258341-99-0
1-Hexadecylpyridinium perfluoro-1-octanesulfonate	334529-63-4



Unless otherwise agreed in writing, this document is issued by the Company subject to its General Conditions of Service printed overleaf, available on request or accessible at <http://www.sgs.com/en/Terms-and-Conditions.aspx> and, for electronic format documents, subject to Terms and Conditions for Electronic Documents at <http://www.sgs.com/en/Terms-and-Conditions/Terms-e-Document.aspx>. Attention is drawn to the limitation of liability, indemnification and jurisdiction issues defined therein. Any holder of this document is advised that information contained hereon reflects the Company's findings at the time of its intervention only and within the limits of Client's instructions, if any. The Company's sole responsibility is to its Client and this document does not exonerate parties to a transaction from exercising all their rights and obligations under the transaction documents. This document cannot be reproduced except in full, without prior written approval of the Company. Any unauthorized alteration, forgery or falsification of the content or appearance of this document is unlawful and offenders may be prosecuted to the fullest extent of the law. Unless otherwise stated the results shown in this test report refer only to the sample(s) tested.

**Attention: To check the authenticity of testing /inspection report & certificate, please contact us at telephone: (86-755) 8307 1443, or email: CN.Doccheck@sgs.com**

# Test Report

No.: NGBEC24007459004\_1

Date: Dec 30, 2024

Page 6 of 21

N,N,N-Triethyldecane-1-aminium heptadecafluorooctane-1-sulfonate	773895-92-4
Tetrabutylphosphonium perfluorooctane sulfonate (PFOS-P (C <sub>4</sub> H <sub>9</sub> ) <sub>4</sub> )	2185049-59-4
Perfluorooctanesulfonic acid diethylamine salt (PFOS-C <sub>4</sub> H <sub>11</sub> N)	2205029-08-7
heptyldimethyl{2-[(2-methylprop-2-enoyl)oxy]ethyl}azanium heptadecafluorooctane-1-sulfonate (PFOS-C <sub>15</sub> H <sub>30</sub> NO <sub>2</sub> )	1203998-97-3
Perfluorooctane sulfonic anhydride (PFOSAN)	423-92-7
<b>FOSAA, its salts</b>	
Perfluorooctane sulfonamidoacetic Acid (FOSAA)	2806-24-8
N-[(Perfluorooctyl)sulfonyl]glycinate (FOSAA(anion))	909405-47-6
N-[(Perfluorooctyl)sulfonyl]glycine potassium salt (1:1) (FOSAA-K)	75260-69-4
N-[(Perfluorooctyl)sulfonyl]glycine sodium salt (1:1) (FOSAA-Na)	115716-87-5
<b>N-MeFOSAA, its salts</b>	
N-Methylperfluoro-1-octanesulfonamidoacetic Acid (N-MeFOSAA)	2355-31-9
2-(N-Methylperfluorooctanesulfonamido)acetate (N-Me-FOSAA(anion))	909405-48-7
Potassium N-((heptadecafluorooctyl)sulphonyl)-N-methylglycinate (N-Me-FOSAA-K)	70281-93-5
<b>N-EtFOSAA, its salts</b>	
N-Ethylperfluorooctane sulfonamidoacetic Acid (N-EtFOSAA)	2991-50-6
Glycine, N-ethyl-N-[(heptadecafluorooctyl)sulfonyl]-, potassium salt (N-Et-FOSAA-K)	2991-51-7
2-(N-Ethyl-perfluorooctanesulfonamido)acetate (N-Et-FOSAA(anion))	909405-49-8
Ammonium 2-(N-ethylperfluorooctanesulfonamido)acetate (N-Et-FOSAA-NH <sub>4</sub> )	2991-52-8
Sodium 2-(N-ethylperfluorooctanesulfonamido)acetate (N-Et-FOSAA-Na)	3871-50-9
<b>PFOSA, its salts</b>	
Perfluorooctane Sulfonamide (PFOSA)	754-91-6
Perfluorooctanesulfonamide lithium salt (1:1) (PFOSA-Li)	76752-79-9
Perfluorooctanesulfonamide Sodium salt (1:1) (PFOSA-Na)	76752-78-8
Perfluorooctanesulfonamide Potassium salt (1:1) (PFOSA-K)	76752-70-0
Perfluorooctanesulfonamide Ammonium salt (1:1) (PFOSA-NH <sub>4</sub> )	76752-72-2
Heptadecafluorooctane-1-sulphonamide, compound with triethylamine (1:1) (PFOSA-C <sub>6</sub> H <sub>15</sub> N)	76752-82-4
<b>PFOA, its salts &amp; derivatives</b>	
Perfluorooctanoic acid (PFOA)	335-67-1
Sodium perfluorooctanoate (PFOA-Na)	335-95-5
Potassium perfluorooctanoate (PFOA-K)	2395-00-8
Silver perfluorooctanoate (PFOA-Ag)	335-93-3
Perfluorooctanoyl fluoride (PFOA-F)	335-66-0
Ammonium pentadecafluorooctanoate (APFO)	3825-26-1
Lithium perfluorooctanoate (PFOA-Li)	17125-58-5
Cobalt perfluorooctanoate (PFOA-Co)	35965-01-6



SGS-CSI Standards Technical Services Co., Ltd.  
Ningbo Branch Chemical Laboratory

Unless otherwise agreed in writing, this document is issued by the Company subject to its General Conditions of Service printed overleaf, available on request or accessible at <http://www.sgs.com/en/Terms-and-Conditions.aspx> and, for electronic format documents, subject to Terms and Conditions for Electronic Documents at <http://www.sgs.com/en/Terms-and-Conditions/Terms-e-Document.aspx>. Attention is drawn to the limitation of liability, indemnification and jurisdiction issues defined therein. Any holder of this document is advised that information contained hereon reflects the Company's findings at the time of its intervention only and within the limits of Client's instructions, if any. The Company's sole responsibility is to its Client and this document does not exonerate parties to a transaction from exercising all their rights and obligations under the transaction documents. This document cannot be reproduced except in full, without prior written approval of the Company. Any unauthorized alteration, forgery or falsification of the content or appearance of this document is unlawful and offenders may be prosecuted to the fullest extent of the law. Unless otherwise stated the results shown in this test report refer only to the sample(s) tested.

Attention: To check the authenticity of testing / inspection report & certificate, please contact us at telephone: (86-755) 8307 1443, or email: [CN.Doccheck@sgs.com](mailto:CN.Doccheck@sgs.com)

No.1177, Lingyun Road, Hi-Tech Zone, Ningbo, Zhejiang, China 315040 tE&E (86-574)89070249

[www.sgs.com](http://www.sgs.com)

中国·浙江·宁波高新区凌云路1177号 邮编: 315040 tHL (86-574)89070271 tML (86-574)89070242 [sgs.china@sgs.com](mailto:sgs.china@sgs.com)

# Test Report

No.: NGBEC24007459004\_1

Date: Dec 30, 2024

Page 7 of 21

Cesium perfluorooctanoate (PFOA-Cs)	17125-60-9
Octanoic acid, 2,2,3,3,4,4,5,5,6,6,7,7,8,8,8-pentadecafluoro-, chromium(3+) (PFOA-Cr(3+))	68141-02-6
Pentadecafluorooctanoic acid--piperazine (2/1) (PFOA-NH(C <sub>4</sub> H <sub>10</sub> N))	423-52-9
Pentadecafluorooctanoate (anion)	45285-51-6
Perfluorooctanoic Anhydride	33496-48-9
N,N,N-Triethylethanaminium perfluorooctanoate	98241-25-9
Perfluorooctanoate N,N,N-Trimethylmethanaminium	32609-65-7
Tetrapropylammonium perfluorooctanoate	277749-00-5
Potassium pentadecafluorooctanoate--water (1/1/2) (PFOA-K(H <sub>2</sub> O) <sub>2</sub> )	98065-31-7
Perfluorooctanoic acid compd. with ethanamine (1:1) (PFOA-C <sub>2</sub> H <sub>7</sub> N)	1376936-03-6
Pentadecafluorooctanoic acid--pyridine (1/1) (PFOA-C <sub>5</sub> H <sub>5</sub> N)	95658-47-2
pentadecafluorooctanoic acid- 1-phenylpiperazine(1:1) (PFOA-C <sub>10</sub> H <sub>14</sub> N <sub>2</sub> )	1514-68-7
N,N,N-Trimethyloctan-1-aminium pentadecafluorooctanoate (PFOA-C <sub>11</sub> H <sub>26</sub> N)	927835-01-6

## AfPS GS 2019:01 PAK-Polycyclic Aromatic Hydrocarbons (PAHs)

**Test Method:** With reference to AfPS GS 2019:01 PAK, analysis was performed by GC-MS.

Test Item(s)	CAS No.	Unit(s)	MDL	A1
Benzo(a)pyrene(BaP)	50-32-8	mg/kg	0.1	ND
Benzo(e)pyrene(BeP)	192-97-2	mg/kg	0.1	ND
Benzo(a)anthracene(BaA)	56-55-3	mg/kg	0.1	ND
Benzo(b)Fluoranthene(BbF)	205-99-2	mg/kg	0.1	ND
Benzo(j)fluoranthene(BjF)	205-82-3	mg/kg	0.1	ND
Benzo(k)Fluoranthene(BkF)	207-08-9	mg/kg	0.1	ND
Chrysene(CHR)	218-01-9	mg/kg	0.1	ND
Dibenzo(a,h)Anthracene(DBA)	53-70-3	mg/kg	0.1	ND
Benzo(g,h,i)perylene(BPE)	191-24-2	mg/kg	0.1	ND
Indeno(1,2,3-c,d)pyrene(IPY)	193-39-5	mg/kg	0.1	ND
Phenanthrene(PHE)	85-01-8	mg/kg	0.1	ND
Pyrene(PYR)	129-00-0	mg/kg	0.1	ND
Anthracene(ANT)	120-12-7	mg/kg	0.1	ND
Fluoranthene(FLT)	206-44-0	mg/kg	0.1	ND
Sum of Phenanthrene(PHE), Pyrene(PYR), Anthracene(ANT), Fluoranthene(FLT)	-	mg/kg	-	ND
Naphthalene(NAP)	91-20-3	mg/kg	0.1	ND
Sum of 15 PAHs	-	mg/kg	-	ND

**Notes:**

**AfPS (German commission for Product Safety) : PAHs requirements**

Parameter	Category 1	Category 2	Category 3
-----------	------------	------------	------------



Unless otherwise agreed in writing, this document is issued by the Company subject to its General Conditions of Service printed overleaf, available on request or accessible at <http://www.sgs.com/en/Terms-and-Conditions.aspx> and, for electronic format documents, subject to Terms and Conditions for Electronic Documents at <http://www.sgs.com/en/Terms-and-Conditions/Terms-e-Document.aspx>. Attention is drawn to the limitation of liability, indemnification and jurisdiction issues defined therein. Any holder of this document is advised that information contained hereon reflects the Company's findings at the time of its intervention only and within the limits of Client's instructions, if any. The Company's sole responsibility is to its Client and this document does not exonerate parties to a transaction from exercising all their rights and obligations under the transaction documents. This document cannot be reproduced except in full, without prior written approval of the Company. Any unauthorized alteration, forgery or falsification of the content or appearance of this document is unlawful and offenders may be prosecuted to the fullest extent of the law. Unless otherwise stated the results shown in this test report refer only to the sample(s) tested.

Attention: To check the authenticity of testing /inspection report & certificate, please contact us at telephone: (86-755) 8307 1443, or email: [CN.Doccheck@sgs.com](mailto:CN.Doccheck@sgs.com)

SGS-CS17 Standards Technical Services Co., Ltd.  
Ningbo Branch Chemical Laboratory

No.1177, Lingyun Road, Hi-Tech Zone, Ningbo, Zhejiang, China 315040 tE&E (86-574)89070249  
中国·浙江·宁波高新区凌云路1177号 邮编: 315040 tHL (86-574)89070271 tML (86-574)89070242 sgs.china@sgs.com

www.sgs.com.cn  
sgs.china@sgs.com

**Test Report**

No.: NGBEC24007459004\_1

Date: Dec 30, 2024

Page 8 of 21

	Materials intended to be placed in the mouth, or materials coming into long-term contact with skin (more than 30s) during the intended use -in toys according to Directive 2009/48/EC or -for the use by children <sup>a,b</sup> up to 3 years of age.	Materials not covered by category 1, coming into long-term contact (more than 30s) or short-term repetitive contact <sup>c</sup> with skin during the intended or foreseeable use <sup>d</sup> .		Materials covered neither by category 1 nor by category 2, coming into short-term contact (up to 30s) with skin during the intended or foreseeable use.	
		a. use by children	b. other consumer products	a. use by children	b. other consumer products
Benzo(a)pyrene (BaP) mg/kg	< 0.2	< 0.2	< 0.5	< 0.5	< 1
Benzo(e)pyrene (BeP) mg/kg	< 0.2	< 0.2	< 0.5	< 0.5	< 1
Benzo(a)anthracene (BaA) mg/kg	< 0.2	< 0.2	< 0.5	< 0.5	< 1
Benzo(b)fluoranthene (BbF) mg/kg	< 0.2	< 0.2	< 0.5	< 0.5	< 1
Benzo(j)fluoranthene (BjF) mg/kg	< 0.2	< 0.2	< 0.5	< 0.5	< 1
Benzo(k)fluoranthene (BkF)mg/kg	< 0.2	< 0.2	< 0.5	< 0.5	< 1
Chrysene (CHR) mg/kg	< 0.2	< 0.2	< 0.5	< 0.5	< 1
Dibenzo(a,h)anthracene (DBA) mg/kg	< 0.2	< 0.2	< 0.5	< 0.5	< 1
Benzo(g,h,i)perylene (BPE) mg/kg	< 0.2	< 0.2	< 0.5	< 0.5	< 1
Indeno(1,2,3-cd)pyrene (IPY) mg/kg	< 0.2	< 0.2	< 0.5	< 0.5	< 1
Phenanthrene (PHE), pyrene (PYR), anthracene (ANT), fluoranthene (FLT), mg/kg	< 1 Sum	< 5 Sum	< 10 Sum	< 20 Sum	< 50 Sum



Unless otherwise agreed in writing, this document is issued by the Company subject to its General Conditions of Service printed overleaf, available on request or accessible at <http://www.sgs.com/en/Terms-and-Conditions.aspx> and, for electronic format documents, subject to Terms and Conditions for Electronic Documents at <http://www.sgs.com/en/Terms-and-Conditions/Terms-e-Document.aspx>. Attention is drawn to the limitation of liability, indemnification and jurisdiction issues defined therein. Any holder of this document is advised that information contained hereon reflects the Company's findings at the time of its intervention only and within the limits of Client's instructions, if any. The Company's sole responsibility is to its Client and this document does not exonerate parties to a transaction from exercising all their rights and obligations under the transaction documents. This document cannot be reproduced except in full, without prior written approval of the Company. Any unauthorized alteration, forgery or falsification of the content or appearance of this document is unlawful and offenders may be prosecuted to the fullest extent of the law. Unless otherwise stated the results shown in this test report refer only to the sample(s) tested.

Attention: To check the authenticity of testing /inspection report & certificate, please contact us at telephone: (86-755) 8307 1443, or email: [CN.Doccheck@sgs.com](mailto:CN.Doccheck@sgs.com)



# Test Report

No.: NGBEC24007459004\_1

Date: Dec 30, 2024

Page 9 of 21

Naphthalene (NAP) mg/kg	< 1	< 2		< 10	
<b>Sum of 15 PAHs</b>	<1	< 5	< 10	< 20	< 50

**Notes:**

- <sup>a</sup> A "Child" is legally defined as a person before reaching the age of 14 years.
- <sup>b</sup> Use by children includes both active and passive contact by children.
- <sup>c</sup> Definition "short-term repetitive contact" taken from REACH Annex XVII entry 50 amendment (Regulation (EC) No.1272/2013)
- <sup>d</sup> According to the definition of the German Product Safety Act (ProdSG) (chapter 1 Article 2 No. 28) "foreseeable use" shall mean the use of a product in a manner that the person placing it on the market, has not intended, but which could be reasonably foreseeable.

**Remark:**

The German committee on Product Safety (AfPS) published a new PAHs document (AfPS GS 2019:01 PAK) on April 10, 2020, which will be binding for the issue of GS mark certificate from July 1, 2020.

This report updated Client Ref. Information.

Unless otherwise stated, the decision rule for conformity reporting is based on Binary Statement for Simple Acceptance Rule ( $w=0$ ) stated in ILAC-G8:09/2019.



Unless otherwise agreed in writing, this document is issued by the Company subject to its General Conditions of Service printed overleaf, available on request or accessible at <http://www.sgs.com/en/Terms-and-Conditions.aspx> and, for electronic format documents, subject to Terms and Conditions for Electronic Documents at <http://www.sgs.com/en/Terms-and-Conditions/Terms-e-Document.aspx>. Attention is drawn to the limitation of liability, indemnification and jurisdiction issues defined therein. Any holder of this document is advised that information contained hereon reflects the Company's findings at the time of its intervention only and within the limits of Client's instructions, if any. The Company's sole responsibility is to its Client and this document does not exonerate parties to a transaction from exercising all their rights and obligations under the transaction documents. This document cannot be reproduced except in full, without prior written approval of the Company. Any unauthorized alteration, forgery or falsification of the content or appearance of this document is unlawful and offenders may be prosecuted to the fullest extent of the law. Unless otherwise stated the results shown in this test report refer only to the sample(s) tested.  
**Attention: To check the authenticity of testing /inspection report & certificate, please contact us at telephone: (86-755) 8307 1443, or email: CN.Doccheck@sgs.com**

**Elements Testing Flow Chart**

These samples were dissolved totally by pre-conditioning method according to below flow chart.

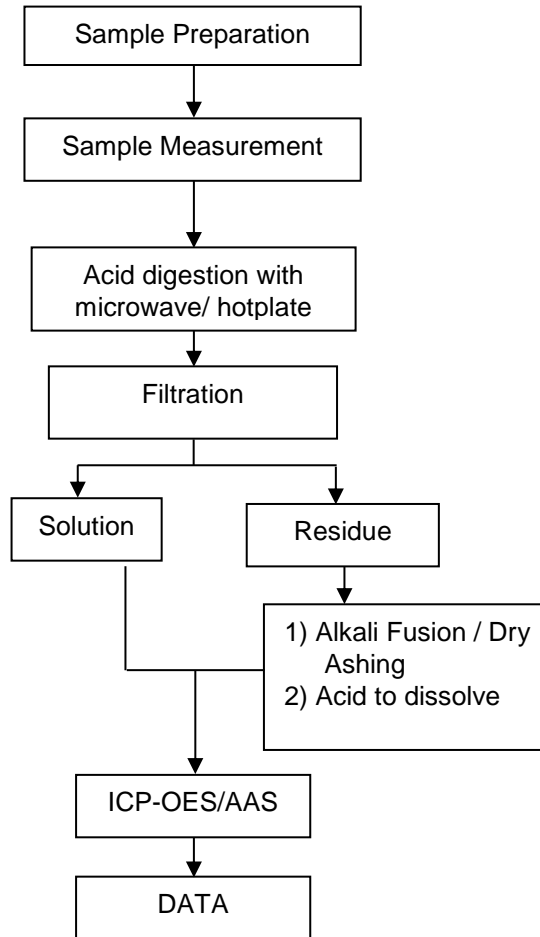

Unless otherwise agreed in writing, this document is issued by the Company subject to its General Conditions of Service printed overleaf, available on request or accessible at <http://www.sgs.com/en/Terms-and-Conditions.aspx> and, for electronic format documents, subject to Terms and Conditions for Electronic Documents at <http://www.sgs.com/en/Terms-and-Conditions/Terms-e-Document.aspx>. Attention is drawn to the limitation of liability, indemnification and jurisdiction issues defined therein. Any holder of this document is advised that information contained hereon reflects the Company's findings at the time of its intervention only and within the limits of Client's instructions, if any. The Company's sole responsibility is to its Client and this document does not exonerate parties to a transaction from exercising all their rights and obligations under the transaction documents. This document cannot be reproduced except in full, without prior written approval of the Company. Any unauthorized alteration, forgery or falsification of the content or appearance of this document is unlawful and offenders may be prosecuted to the fullest extent of the law. Unless otherwise stated the results shown in this test report refer only to the sample(s) tested.

Attention: To check the authenticity of testing /inspection report & certificate, please contact us at telephone: (86-755) 8307 1443, or email: [CN.Doccheck@sgs.com](mailto:CN.Doccheck@sgs.com)

**Hexavalent Chromium (Cr(VI)) Testing Flow Chart**

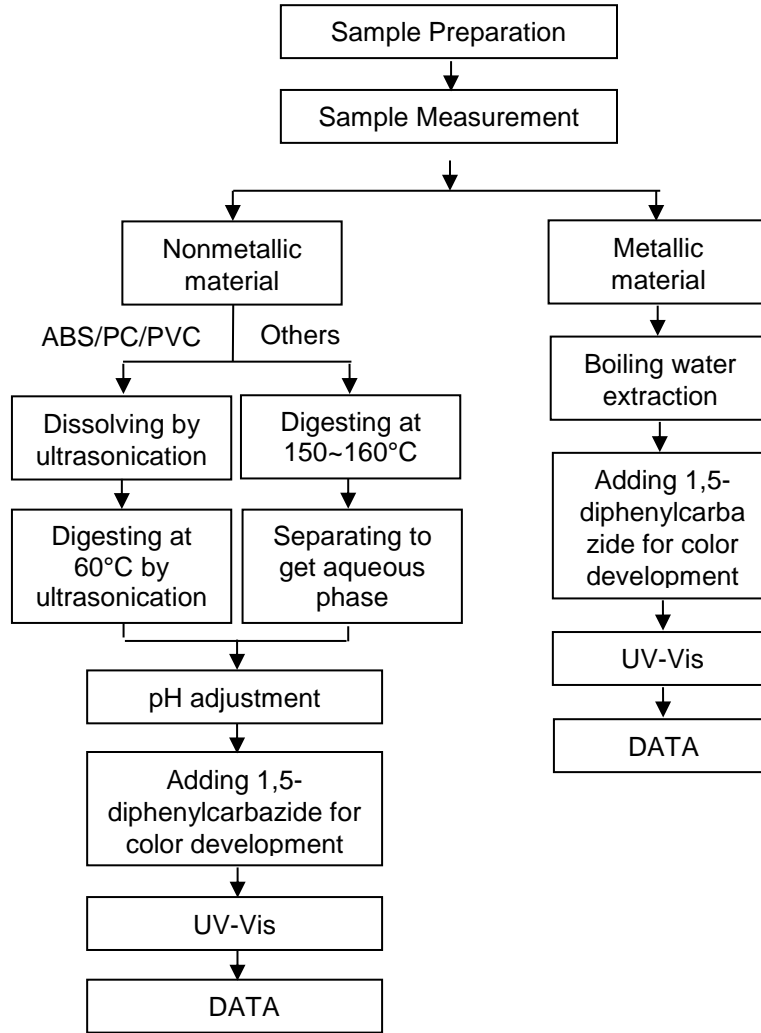

Unless otherwise agreed in writing, this document is issued by the Company subject to its General Conditions of Service printed overleaf, available on request or accessible at <http://www.sgs.com/en/Terms-and-Conditions.aspx> and, for electronic format documents, subject to Terms and Conditions for Electronic Documents at <http://www.sgs.com/en/Terms-and-Conditions/Terms-e-Document.aspx>. Attention is drawn to the limitation of liability, indemnification and jurisdiction issues defined therein. Any holder of this document is advised that information contained hereon reflects the Company's findings at the time of its intervention only and within the limits of Client's instructions, if any. The Company's sole responsibility is to its Client and this document does not exonerate parties to a transaction from exercising all their rights and obligations under the transaction documents. This document cannot be reproduced except in full, without prior written approval of the Company. Any unauthorized alteration, forgery or falsification of the content or appearance of this document is unlawful and offenders may be prosecuted to the fullest extent of the law. Unless otherwise stated the results shown in this test report refer only to the sample(s) tested.

**Attention: To check the authenticity of testing /inspection report & certificate, please contact us at telephone: (86-755) 8307 1443, or email: CN.Doccheck@sgs.com**

**PBB/PBDE/Phthalates Testing Flow Chart**

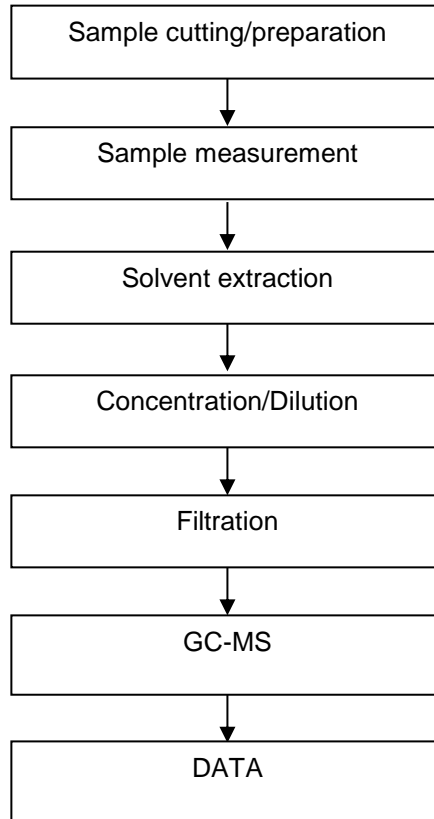

Unless otherwise agreed in writing, this document is issued by the Company subject to its General Conditions of Service printed overleaf, available on request or accessible at <http://www.sgs.com/en/Terms-and-Conditions.aspx> and, for electronic format documents, subject to Terms and Conditions for Electronic Documents at <http://www.sgs.com/en/Terms-and-Conditions/Terms-e-Document.aspx>. Attention is drawn to the limitation of liability, indemnification and jurisdiction issues defined therein. Any holder of this document is advised that information contained hereon reflects the Company's findings at the time of its intervention only and within the limits of Client's instructions, if any. The Company's sole responsibility is to its Client and this document does not exonerate parties to a transaction from exercising all their rights and obligations under the transaction documents. This document cannot be reproduced except in full, without prior written approval of the Company. Any unauthorized alteration, forgery or falsification of the content or appearance of this document is unlawful and offenders may be prosecuted to the fullest extent of the law. Unless otherwise stated the results shown in this test report refer only to the sample(s) tested.

**Attention: To check the authenticity of testing /inspection report & certificate, please contact us at telephone: (86-755) 8307 1443, or email: [CN.Doccheck@sgs.com](mailto:CN.Doccheck@sgs.com)**

### Elements Testing Flow Chart

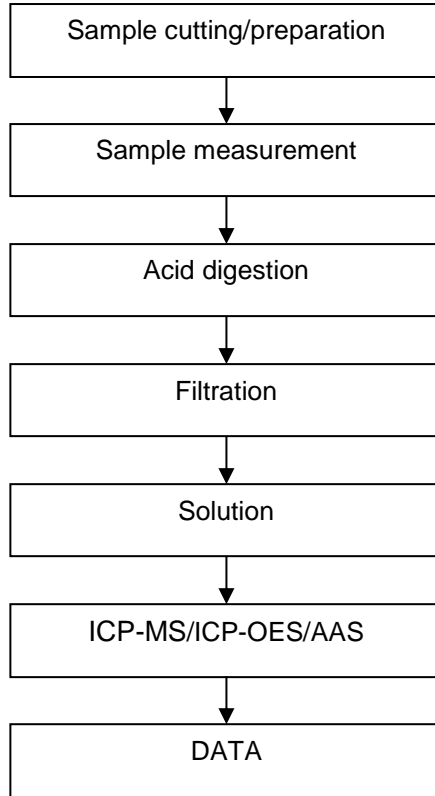

Unless otherwise agreed in writing, this document is issued by the Company subject to its General Conditions of Service printed overleaf, available on request or accessible at <http://www.sgs.com/en/Terms-and-Conditions.aspx> and, for electronic format documents, subject to Terms and Conditions for Electronic Documents at <http://www.sgs.com/en/Terms-and-Conditions/Terms-e-Document.aspx>. Attention is drawn to the limitation of liability, indemnification and jurisdiction issues defined therein. Any holder of this document is advised that information contained hereon reflects the Company's findings at the time of its intervention only and within the limits of Client's instructions, if any. The Company's sole responsibility is to its Client and this document does not exonerate parties to a transaction from exercising all their rights and obligations under the transaction documents. This document cannot be reproduced except in full, without prior written approval of the Company. Any unauthorized alteration, forgery or falsification of the content or appearance of this document is unlawful and offenders may be prosecuted to the fullest extent of the law. Unless otherwise stated the results shown in this test report refer only to the sample(s) tested.

**Attention: To check the authenticity of testing /inspection report & certificate, please contact us at telephone: (86-755) 8307 1443, or email: [CN.Doccheck@sgs.com](mailto:CN.Doccheck@sgs.com)**

### Halogen Testing Flow Chart

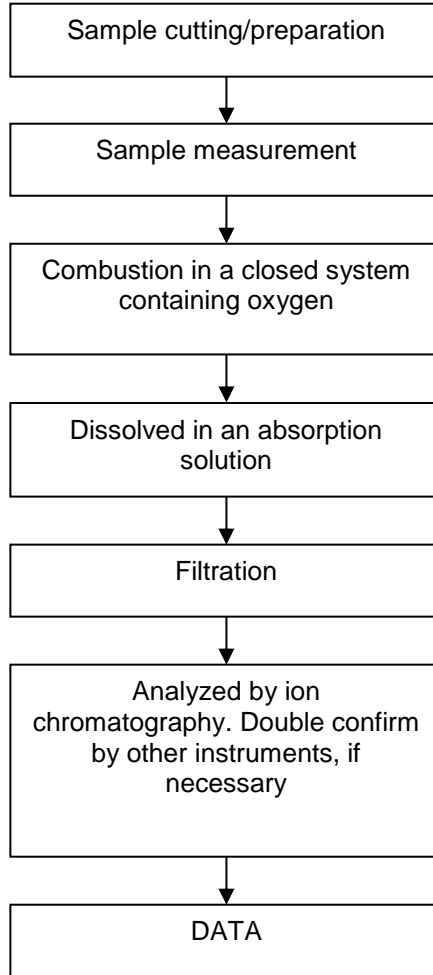

Unless otherwise agreed in writing, this document is issued by the Company subject to its General Conditions of Service printed overleaf, available on request or accessible at <http://www.sgs.com/en/Terms-and-Conditions.aspx> and, for electronic format documents, subject to Terms and Conditions for Electronic Documents at <http://www.sgs.com/en/Terms-and-Conditions/Terms-e-Document.aspx>. Attention is drawn to the limitation of liability, indemnification and jurisdiction issues defined therein. Any holder of this document is advised that information contained hereon reflects the Company's findings at the time of its intervention only and within the limits of Client's instructions, if any. The Company's sole responsibility is to its Client and this document does not exonerate parties to a transaction from exercising all their rights and obligations under the transaction documents. This document cannot be reproduced except in full, without prior written approval of the Company. Any unauthorized alteration, forgery or falsification of the content or appearance of this document is unlawful and offenders may be prosecuted to the fullest extent of the law. Unless otherwise stated the results shown in this test report refer only to the sample(s) tested.

Attention: To check the authenticity of testing /inspection report & certificate, please contact us at telephone: (86-755) 8307 1443, or email: [CN.Doccheck@sgs.com](mailto:CN.Doccheck@sgs.com)

### PVC Testing Flow Chart

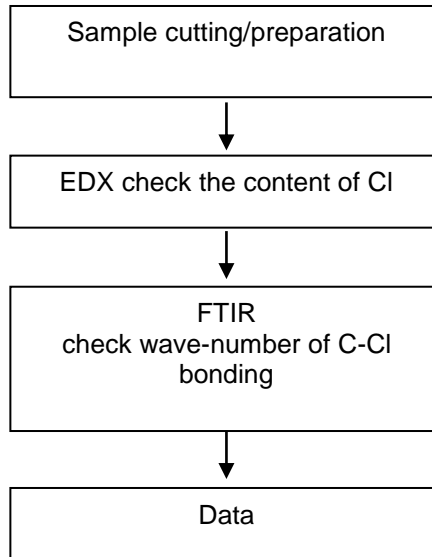

Unless otherwise agreed in writing, this document is issued by the Company subject to its General Conditions of Service printed overleaf, available on request or accessible at <http://www.sgs.com/en/Terms-and-Conditions.aspx> and, for electronic format documents, subject to Terms and Conditions for Electronic Documents at <http://www.sgs.com/en/Terms-and-Conditions/Terms-e-Document.aspx>. Attention is drawn to the limitation of liability, indemnification and jurisdiction issues defined therein. Any holder of this document is advised that information contained hereon reflects the Company's findings at the time of its intervention only and within the limits of Client's instructions, if any. The Company's sole responsibility is to its Client and this document does not exonerate parties to a transaction from exercising all their rights and obligations under the transaction documents. This document cannot be reproduced except in full, without prior written approval of the Company. Any unauthorized alteration, forgery or falsification of the content or appearance of this document is unlawful and offenders may be prosecuted to the fullest extent of the law. Unless otherwise stated the results shown in this test report refer only to the sample(s) tested.

**Attention: To check the authenticity of testing /inspection report & certificate, please contact us at telephone: (86-755) 8307 1443, or email: [CN.Doccheck@sgs.com](mailto:CN.Doccheck@sgs.com)**

### Red Phosphorus Testing Flow Chart

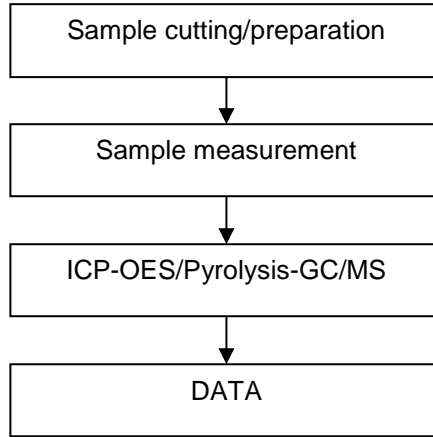

Unless otherwise agreed in writing, this document is issued by the Company subject to its General Conditions of Service printed overleaf, available on request or accessible at <http://www.sgs.com/en/Terms-and-Conditions.aspx> and, for electronic format documents, subject to Terms and Conditions for Electronic Documents at <http://www.sgs.com/en/Terms-and-Conditions/Terms-e-Document.aspx>. Attention is drawn to the limitation of liability, indemnification and jurisdiction issues defined therein. Any holder of this document is advised that information contained hereon reflects the Company's findings at the time of its intervention only and within the limits of Client's instructions, if any. The Company's sole responsibility is to its Client and this document does not exonerate parties to a transaction from exercising all their rights and obligations under the transaction documents. This document cannot be reproduced except in full, without prior written approval of the Company. Any unauthorized alteration, forgery or falsification of the content or appearance of this document is unlawful and offenders may be prosecuted to the fullest extent of the law. Unless otherwise stated the results shown in this test report refer only to the sample(s) tested.

**Attention: To check the authenticity of testing /inspection report & certificate, please contact us at telephone: (86-755) 8307 1443, or email: [CN.Doccheck@sgs.com](mailto:CN.Doccheck@sgs.com)**



### HBCDD Testing Flow Chart

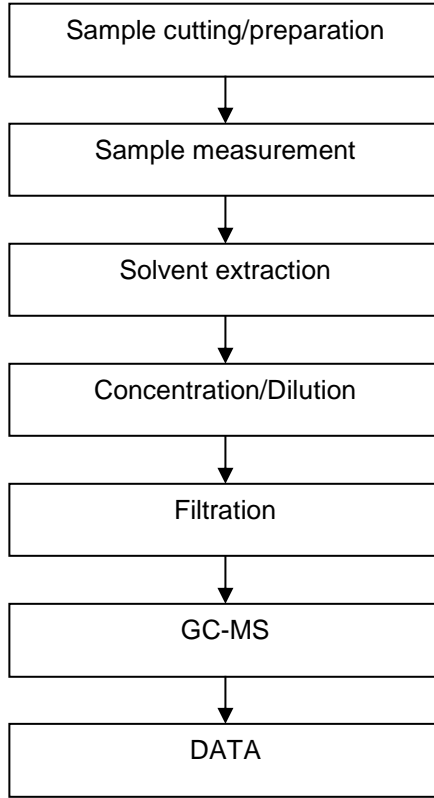

Unless otherwise agreed in writing, this document is issued by the Company subject to its General Conditions of Service printed overleaf, available on request or accessible at <http://www.sgs.com/en/Terms-and-Conditions.aspx> and, for electronic format documents, subject to Terms and Conditions for Electronic Documents at <http://www.sgs.com/en/Terms-and-Conditions/Terms-e-Document.aspx>. Attention is drawn to the limitation of liability, indemnification and jurisdiction issues defined therein. Any holder of this document is advised that information contained hereon reflects the Company's findings at the time of its intervention only and within the limits of Client's instructions, if any. The Company's sole responsibility is to its Client and this document does not exonerate parties to a transaction from exercising all their rights and obligations under the transaction documents. This document cannot be reproduced except in full, without prior written approval of the Company. Any unauthorized alteration, forgery or falsification of the content or appearance of this document is unlawful and offenders may be prosecuted to the fullest extent of the law. Unless otherwise stated the results shown in this test report refer only to the sample(s) tested.

Attention: To check the authenticity of testing /inspection report & certificate, please contact us at telephone: (86-755) 8307 1443, or email: [CN.Doccheck@sgs.com](mailto:CN.Doccheck@sgs.com)

### PFASs/ PFOS/PFOA Testing Flow Chart

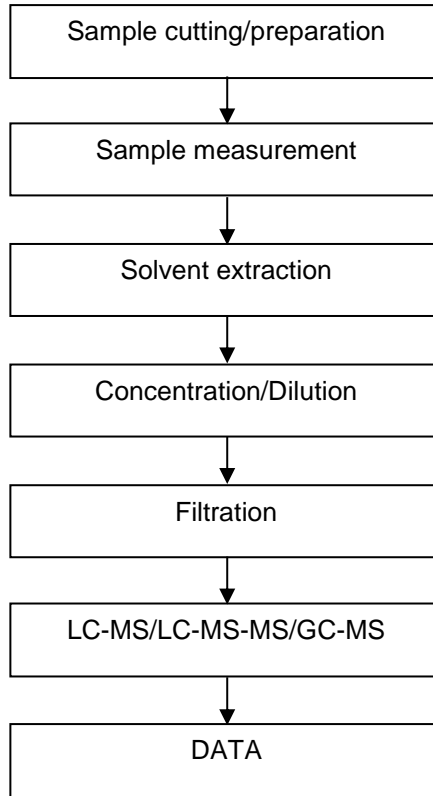

Unless otherwise agreed in writing, this document is issued by the Company subject to its General Conditions of Service printed overleaf, available on request or accessible at <http://www.sgs.com/en/Terms-and-Conditions.aspx> and, for electronic format documents, subject to Terms and Conditions for Electronic Documents at <http://www.sgs.com/en/Terms-and-Conditions/Terms-e-Document.aspx>. Attention is drawn to the limitation of liability, indemnification and jurisdiction issues defined therein. Any holder of this document is advised that information contained hereon reflects the Company's findings at the time of its intervention only and within the limits of Client's instructions, if any. The Company's sole responsibility is to its Client and this document does not exonerate parties to a transaction from exercising all their rights and obligations under the transaction documents. This document cannot be reproduced except in full, without prior written approval of the Company. Any unauthorized alteration, forgery or falsification of the content or appearance of this document is unlawful and offenders may be prosecuted to the fullest extent of the law. Unless otherwise stated the results shown in this test report refer only to the sample(s) tested.

Attention: To check the authenticity of testing /inspection report & certificate, please contact us at telephone: (86-755) 8307 1443, or email: [CN.Doccheck@sgs.com](mailto:CN.Doccheck@sgs.com)

### PAHs Testing Flow Chart

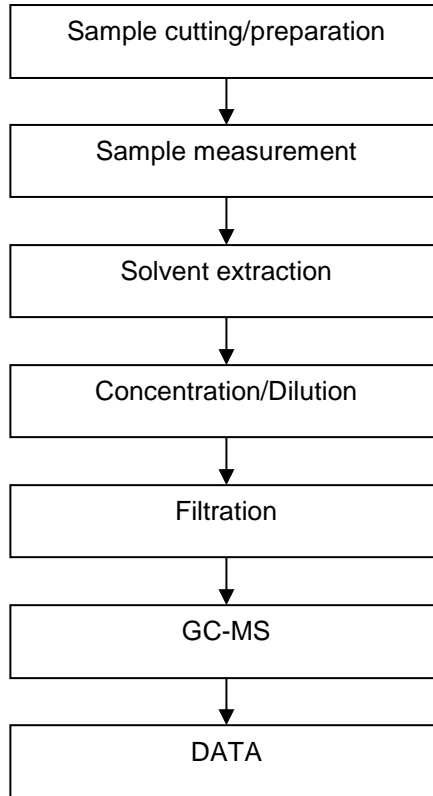

Unless otherwise agreed in writing, this document is issued by the Company subject to its General Conditions of Service printed overleaf, available on request or accessible at <http://www.sgs.com/en/Terms-and-Conditions.aspx> and, for electronic format documents, subject to Terms and Conditions for Electronic Documents at <http://www.sgs.com/en/Terms-and-Conditions/Terms-e-Document.aspx>. Attention is drawn to the limitation of liability, indemnification and jurisdiction issues defined therein. Any holder of this document is advised that information contained hereon reflects the Company's findings at the time of its intervention only and within the limits of Client's instructions, if any. The Company's sole responsibility is to its Client and this document does not exonerate parties to a transaction from exercising all their rights and obligations under the transaction documents. This document cannot be reproduced except in full, without prior written approval of the Company. Any unauthorized alteration, forgery or falsification of the content or appearance of this document is unlawful and offenders may be prosecuted to the fullest extent of the law. Unless otherwise stated the results shown in this test report refer only to the sample(s) tested.

Attention: To check the authenticity of testing /inspection report & certificate, please contact us at telephone: (86-755) 8307 1443, or email: [CN.Doccheck@sgs.com](mailto:CN.Doccheck@sgs.com)

## Test Report

No.: NGBEC24007459004\_1

Date: Dec 30, 2024

Page 20 of 21

Attachment:

AQFN6x6 BGA2.3\*5.8 BGA3.35\*3.1 BGA3.5x4.5 BGA5.55\*9.00 BGA17\*17 BGA21\*21 COF48-465  
COMBO3.94x2.36x1.35 COMBO4.94x3.36x2.35 CPC5 CPC8  
CSP0.76x0.76 CSP0.78x0.78 CSP0.79x0.79 CSP0.9x0.9 CSP1.23\*0.87 CSP1.29\*1.25 CSP1.31\*1.31  
CSP1.32x1.86 CSP1.338\*0.838 CSP1.35\*2.15 CSP1.39\*1.68 CSP1.41\*1.70 CSP1.43x0.89 CSP1.5x1  
CSP1.50x1.64 CSP1.54x0.90 CSP1.55\*2.55 CSP1.56x1.96 CSP1.6x0.9 CSP1.6\*2 CSP1.62x2.36  
CSP1.65x0.85 CSP1.65x1.25 CSP1.655\*1.802 CSP1.66x1.61 CSP1.73x1.73 CSP1.79x1.46  
CSP1.79x1.57 CSP1.79\*2.01 CSP1.8\*1.8  
CSP1.8\*2.2 CSP1.85\*2.05 CSP1.92x1.92 CSP1.93x2.05 CSP2.0x1.8 CSP2\*2 CSP2.0x2.5  
CSP2.03\*2.51 CSP2.1x1.65 CSP2.2x2.565 CSP2.23x1.73 CSP2.35x2.75 CSP2.38x2.70 CSP2.4x2.4  
CSP2.42x2.82 CSP2.43x1.77 CSP2.44\*2.44 CSP2.53x2.53 CSP2.55\*2.49 CSP2.57x3.71 CSP2.6\*2.6  
CSP2.60x2.68 CSP2.605\*2.605 CSP2.615\*2.615 CSP2.64x1.48 CSP2.64x3.94 CSP2.66x3.89  
CSP2.67x1.51 CSP2.67\*2.67 CSP2.68\*2.68 CSP2.8x2.4 CSP2.8x2.8 CSP2.93x2.73  
CSP2.94x2.51 CSP2.94x3.32 CSP3x2.6 CSP3.0x3.2 CSP3.03x3.34 CSP3.08\*3.30 CSP3.15\*2.75  
CSP3.15x3.5 CSP3.15\*3.11 CSP3.16x4.16 CSP3.2\*2.8 CSP3.21\*2.81 CSP3.215\*4.415  
CSP3.23x3.23 CSP3.3\*3.3 CSP3.35\*3.1 CSP3.35x3.5 CSP3.52x1.66 CSP3.55\*3.50 CSP3.6x9.05  
CSP3.63x3.63 CSP3.65x3.2 CSP3.65\*3.65 CSP4.03x4.66 CSP4.06x4.47 CSP4.12x4.49  
CSP4.13x4.13 CSP4.2x4.2 CSP4.21x4.21 CSP4.55\*4.10 CSP4.82x3.62 CSP4.97x4.45 CSP5x5  
CSP6x6 CSP6x9 CSP6.07x2.52 CSP10x9  
DFN0.4x0.2 DFN0.6x0.3 DFN1.0x0.6 DFN1\*1 DFN1.1x0.85 DFN1.1x0.9 DFN1.2x1.2 DFN1.2x1.6  
DFN1.25x1 DFN1.3x0.8 DFN1.3x0.9 DFN1.4\*1.8 DFN1.45x1.0 DFN1.5x0.9 DFN1.5x1 DFN1.5x1.5  
DFN1.6x1.0 DFN1.6x1.2 DFN1.7\*1.35 DFN1.8\*1.4 DFN2x1 DFN2x1.5 DFN2x2 DFN2x3 DFN2.1\*1.8  
DFN2.5x1.0 DFN2.5\*1.35 DFN2.5x1.5 DFN2.5x2 DFN2.5x2.5 DFN2.5x3 DFN2.5x4 DFN3x1.5  
DFN3x2 DFN3x3 DFN3.3x1.35 DFN3.3x3.3 DFN3.8x1.0 DFN4x2.5 DFN4x3 DFN4x4 DFN4x4.5  
DFN4x5 DFN4.1x2.0 DFN5x5 DFN5x6 DFN5.5x1.5 DFN6.5\*7.0 DFN7x7 DFN7x10 DFN8\*8  
DIP7 DIP8 DIP16 DIP18 DIP-4646 D-SMD D-SMD2520 HDIP12 GEM2021  
GEM2928 LGA2.5x2.5 LGA3\*6 LGA3.8x5.4 LGA4\*6 LGA5x6 LGA5.5x6.5 LGA6\*6 LGA12\*8  
LQFP7x7 LQFP10x10 LQFP12x12 LQFP14x14 LQFP20x20 LQFP24x24  
MDFN1.9\*1.75 MDFN2x2 MDFN2.5x2 MLGA5\*5 MLGA6\*6 MLGA6.7\*6.2 MLGA7\*7 MLGA7.1\*7.1  
MLGA7.1\*8 MLGA7 \*8 MLGA9.2\*5.5 MLGA11\*9 MLGA12\*7.25 MQFN2\*2.5 MQFN2x3  
MQFN2.1\*3 MQFN2.35\*2.9 MQFN2.5\*2.5 MQFN2.5x3 MQFN2.6\*2.55 MQFN2.8x3 MQFN3x3  
MQFN3x4 MQFN3\*5 MQFN3\*6 MQFN3.2\*4.2 MQFN4x5.6 MQFN5x5 MQFN5x6 MQFN5\*7.7  
MQFN5\*7.7 MQFN5.5\*4 MQFN5.5\*9.2 MQFN7x7 MQFN7.1x8 MQFN11.3x7.5 MSOP8 MSOP8E  
MSOP10 ODFN2\*2\*0.7 QFN1.4x1.8 QFN1.5x1.5 QFN1.5x2 QFN1.6x1.6 QFN2x1.5 QFN2x2  
QFN2x2.5 QFN2x3 QFN2.5x2.5 QFN2.5x3 QFN3x3 QFN3\*3.5 QFN3x4 QFN3\*4.5 QFN3x5 QFN3\*6  
QFN3.3\*4.8 QFN3.4\*5.68 QFN3.5x3.5 QFN3.5x4 QFN3.5x4.5 QFN4x3 QFN4x4 QFN4x5 QFN4x6  
QFN4x6.5 QFN4.4x4 QFN4.5x5 QFN5x5 QFN5\*5.5 QFN5x6 QFN5x7 QFN5x7.5 QFN5x8  
QFN5x11 QFN5.5x4 QFN6x5 QFN6x6 QFN7x7 QFN7.5\*7.5 QFN7x8 QFN8x7 QFN8x8 QFN8x9  
QFN8x12 QFN9x8 QFN9x9 QFN10x10 QFN12\*7 QFN12x8 PDFN5\*6 P-DIP6 PLCC-3528 SL-  
SMD3013  
SMB SMC SMP7 SMD0805 SMD1206 SMD1417 SMD2010 SMD2014 SMD2015 SMD2020  
SMD2024 SMD2420 SMD2515 SMD2814 SMD3120 SMD3313 SMD3317 SMD3535 SMD4222  
SOD123 SOD323 SOD523 SOD123FL SOP4 SOP7 SOP8 SOP14 SOP16 SOP20 SOP24 SOP8E  
SOP16E SOP14W SOP16W SOT23 SOT33 SOT89 SOT143 SOT223 SOT235 SOT236 SOT323  
SOT335 SOT336 SOT363 SOT523 SOT563 SOT583 SSOP9 SSOP9E SSOP10 SSOP10E  
SSOP14E SSOP16 SSOP16E SSOP20 SSOP24 SSOP28 SSOP32 SSOP32W SSOP18E  
SSOP24E  
TO92 TO220 TO252 TO263 TO220F TQFP7x7 TQFP10x10 TSOP14E TSSOP8 TSSOP14  
TSSOP14E TSSOP16 TSSOP16E TSSOP20E TSSOP24 SSOP24E TSSOP28 TSSOP28E TSSOP30  
TSSOP32E TSSOP38 TSSOP38E TSOT23  
2ΦRadial-2L 3ΦRadial-2L 5ΦRadial-2L



Unless otherwise agreed in writing, this document is issued by the Company subject to its General Conditions of Service printed overleaf, available on request or accessible at <http://www.sgs.com/en/Terms-and-Conditions.aspx> and, for electronic format documents, subject to Terms and Conditions for Electronic Documents at <http://www.sgs.com/en/Terms-and-Conditions/Terms-e-Document.aspx>. Attention is drawn to the limitation of liability, indemnification and jurisdiction issues defined therein. Any holder of this document is advised that information contained hereon reflects the Company's findings at the time of its intervention only and within the limits of Client's instructions, if any. The Company's sole responsibility is to its Client and this document does not exonerate parties to a transaction from exercising all their rights and obligations under the transaction documents. This document cannot be reproduced except in full, without prior written approval of the Company. Any unauthorized alteration, forgery or falsification of the content or appearance of this document is unlawful and offenders may be prosecuted to the fullest extent of the law. Unless otherwise stated the results shown in this test report refer only to the sample(s) tested.  
**Attention: To check the authenticity of testing / inspection report & certificate, please contact us at telephone: (86-755) 8307 1443, or email: CN.Doccheck@sgs.com**

Sample Photo:



SGS authenticate the photo on original report only  
\*\*\* End of Report \*\*\*



Unless otherwise agreed in writing, this document is issued by the Company subject to its General Conditions of Service printed overleaf, available on request or accessible at <http://www.sgs.com/en/Terms-and-Conditions.aspx> and, for electronic format documents, subject to Terms and Conditions for Electronic Documents at <http://www.sgs.com/en/Terms-and-Conditions/Terms-e-Document.aspx>. Attention is drawn to the limitation of liability, indemnification and jurisdiction issues defined therein. Any holder of this document is advised that information contained hereon reflects the Company's findings at the time of its intervention only and within the limits of Client's instructions, if any. The Company's sole responsibility is to its Client and this document does not exonerate parties to a transaction from exercising all their rights and obligations under the transaction documents. This document cannot be reproduced except in full, without prior written approval of the Company. Any unauthorized alteration, forgery or falsification of the content or appearance of this document is unlawful and offenders may be prosecuted to the fullest extent of the law. Unless otherwise stated the results shown in this test report refer only to the sample(s) tested.

Attention: To check the authenticity of testing / inspection report & certificate, please contact us at telephone: (86-755) 8307 1443, or email: [CN.Doccheck@sgs.com](mailto:CN.Doccheck@sgs.com)